

The original of this drawing is copyright and contains confidential information. It is property of JORC Industrial without whose permission it may NOT be copied, shown or handed to a third party or otherwise used and it is to be returned promptly upon request to JORC Industrial.

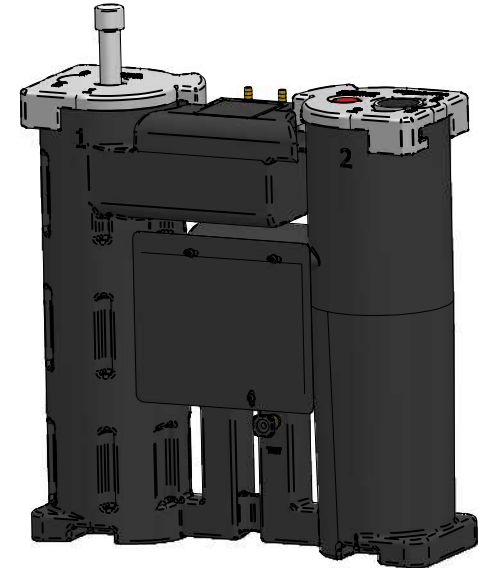
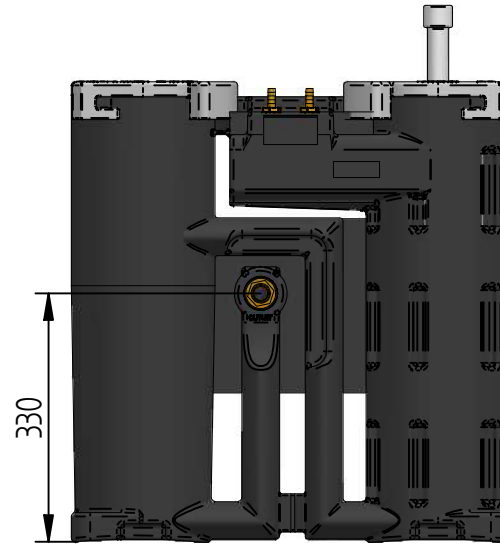
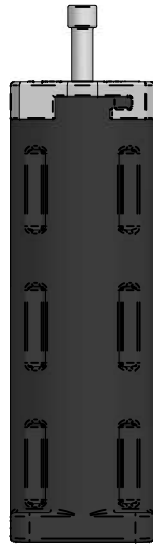
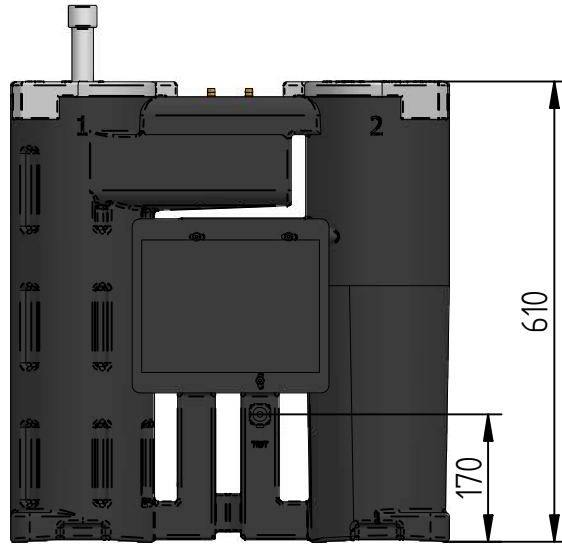
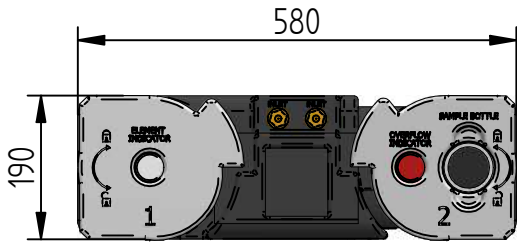

	NAME	DATE			
DRAWN	FK	01-11-2016	SEP premium 175	ARTIKEL NUMBER:	
CHECKED					
JORC Industrial LLC 1146 River Road New Castle, DE 19720 USA National Tel: 302 395 0310 Fax: 302 395 0312 International Tel: +1 302 395 0310 Fax: +1 302 395 0312			SIZE A4	Material:	REV A
			All dimensions are in millimetres unless otherwise stated		